



## GENERAL TECHNICAL DATA

### Dimensions:

- width: 279 cm
- height: 45 cm
- depth: 78 cm

### Weight:

- using softwood: 169 kg
- using hardwood: 180 kg

### Materials:

- stainless steel or carbon steel
- hardwood or softwood

### Electrical specifications:

- max. power of photovoltaic panels: 100 W
- battery capacity: 36 Ah
- operating temperature: -20°C - 60°C

### Basic equipment

- three USB A quick charge ports
- LED ambient light

### Optional equipment:

- inductive charger
- Wi-Fi module
- music module with built-in memory
- bluetooth sound module
- bike racks
- table

## DESCRIPTION

Bent, welded and bolted structure made of 2 - 8 mm thick steel sheets in s235Jr carbon steel galvanised and powder-coated according to RAL palette or entirely in 1.4301 ground stainless steel. Bench equipped with a glass photovoltaic panel with max: 100 W. In the basic version, the bench has three USB A quick charge ports and LED ambient lighting. In the extended version, the bench can be equipped with an inductive charger, a music module with built-in memory and a Wi-Fi hotspot module. Battery capacity: 36 Ah. Operating temperature: -20°C - 60°C.

All landscaping elements must be properly anchored in accordance with the manufacturer's technical instructions. The manufacturer is not liable for damage caused by negligent use or failure to follow the instructions.



**product:** Photon solar bench 02.409.3

**version:** v1

**designer:** Filip Babiarz, Iwona Żaczek



Zano company Miroslaw Zarotyński, in accordance with the Act on Copyright and Related Rights of 04.02.1994 (Journal of Laws No. 24 item 83, amended: Journal of Laws No. 43 item 170 ) as well as with the European Union legislation on copyright protection, including all EU directives and regulations concerning copyright, reserves copyright to drawings, 3D models, renderings, graphics, content contained in offers, annexes to offers and other documents - their content being the intellectual property of ZANO Miroslaw Zarotyński firm; The use of author's ideas, solutions, copying, distribution of photographs, graphics fragments, text descriptions for commercial purposes without the permission of the author - ZANO Miroslaw Zarotyński - is forbidden and constitutes an infringement of copyright and is subject to punishment.

MOUNTING HOLES SPACING



ISOMETRIC VIEW

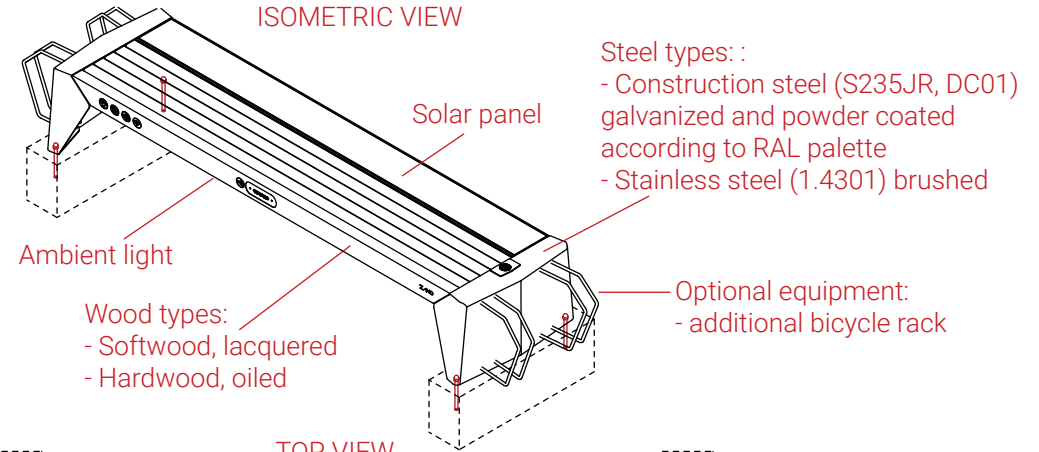

TOP VIEW

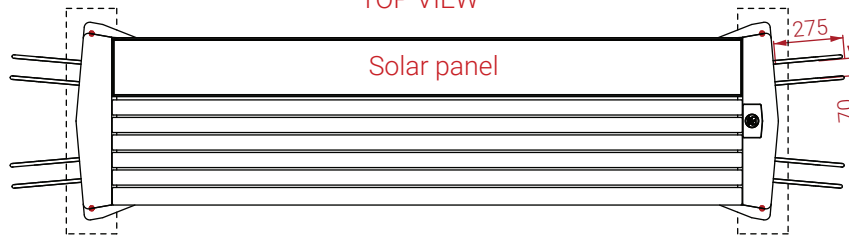

TOP VIEW

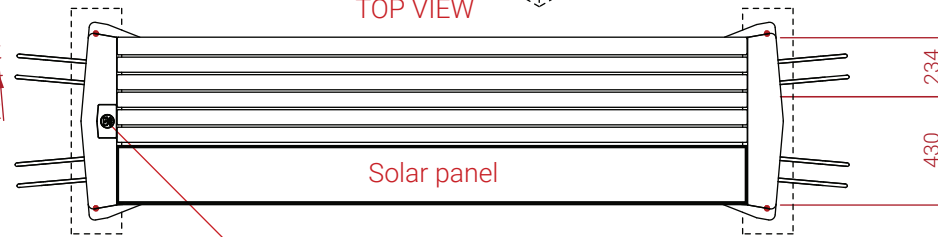

FRONT VIEW

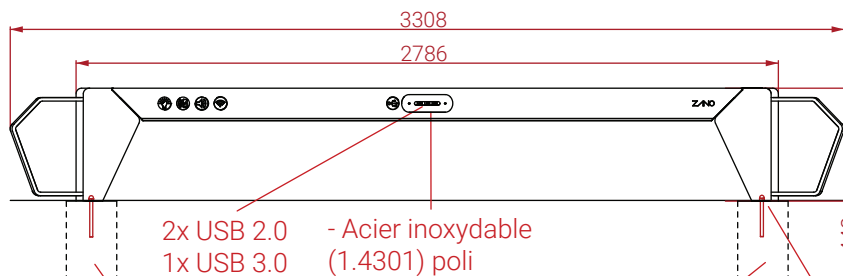

Optional equipment:  
- wireless charger

BACK VIEW

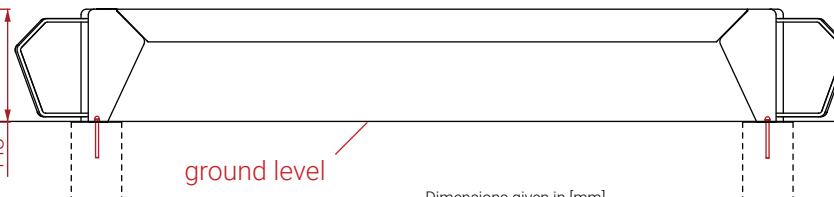

SIDE VIEW

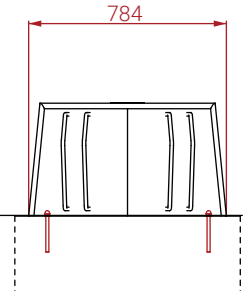

Exemplary concrete foundation

Installation:  
Attached by bolts  
to foundation

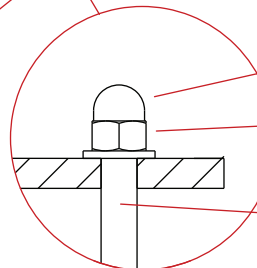

- 4 x Nut M12 Din1587
- 4 x Washer M12 Din125
- 4 x Threaded rod M12 x150 DIN 976-1

Dimensions given in [mm]

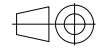
Photon solar bench 02.409.3		 ZANO Street Furniture Lindego 7A, 30-148 Cracow, Poland phone: +48 12 200 20 53 email: office@zano.pl	
In accordance with the Polish Law on Copyright and Related Rights of 04.02.1994 (Official Journal of Laws No. 24, item 83, corrected: Journal of Laws No. 43, item 170) and in accordance with the EU copyright legislation including all EU directives and regulations on copyright - Zano Mirosław Zarotyński Company, reserves the copyright of drawings, descriptions, 3D models, renderings, graphics, content contained in offers, attachments to offers and all other documents. Its content is the intellectual property of ZANO Mirosław Zarotyński company. The use of author's ideas, solutions, copying, distribution of photos, graphics or fragments of graphics, descriptive texts, for profit, without the permission of the author - ZANO Mirosław Zarotyński company - is prohibited and constitutes a copyright infringement and is punishable.		Number:	130423-V1
Sheet:	A4		
Scale:	1:30		
		with softwood 169 kg with hardwood 180 kg	