



ZANO Smart City



Solar energy



Eco friendly



Wi-Fi hotspot



Induction charger



Bluetooth speaker/
built in memory



Quick charge USB



Induction loop



LED light

PHOTON

solar bench

ZANO Smart City, a product line comprising solar powered facilities such as charging stations or smart benches.

UNIVERSE
Solar station



FLASH
Solar bench

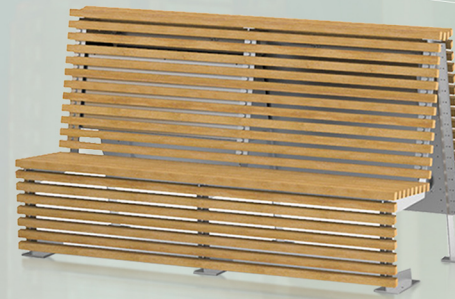
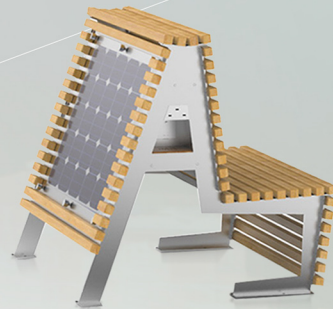

SUNFLOWER
Solar station

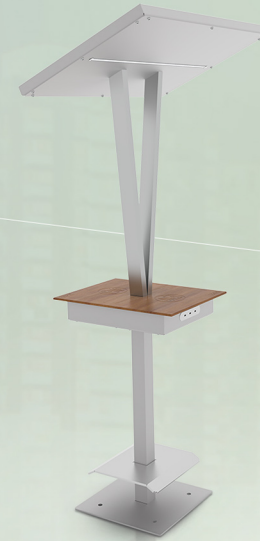

PHOTON
Solar bench



We offer products that are part of a bigger line of street furniture (**Universe, Flash, Photon**) as well as individual units (the **Sunflower** solar station).



PHOTON smart solar bench variants

Photon 02.409
solar bench



Photon 02.409.2
standard bench (connected to the power grid)







Photon 02.409.1
standard bench

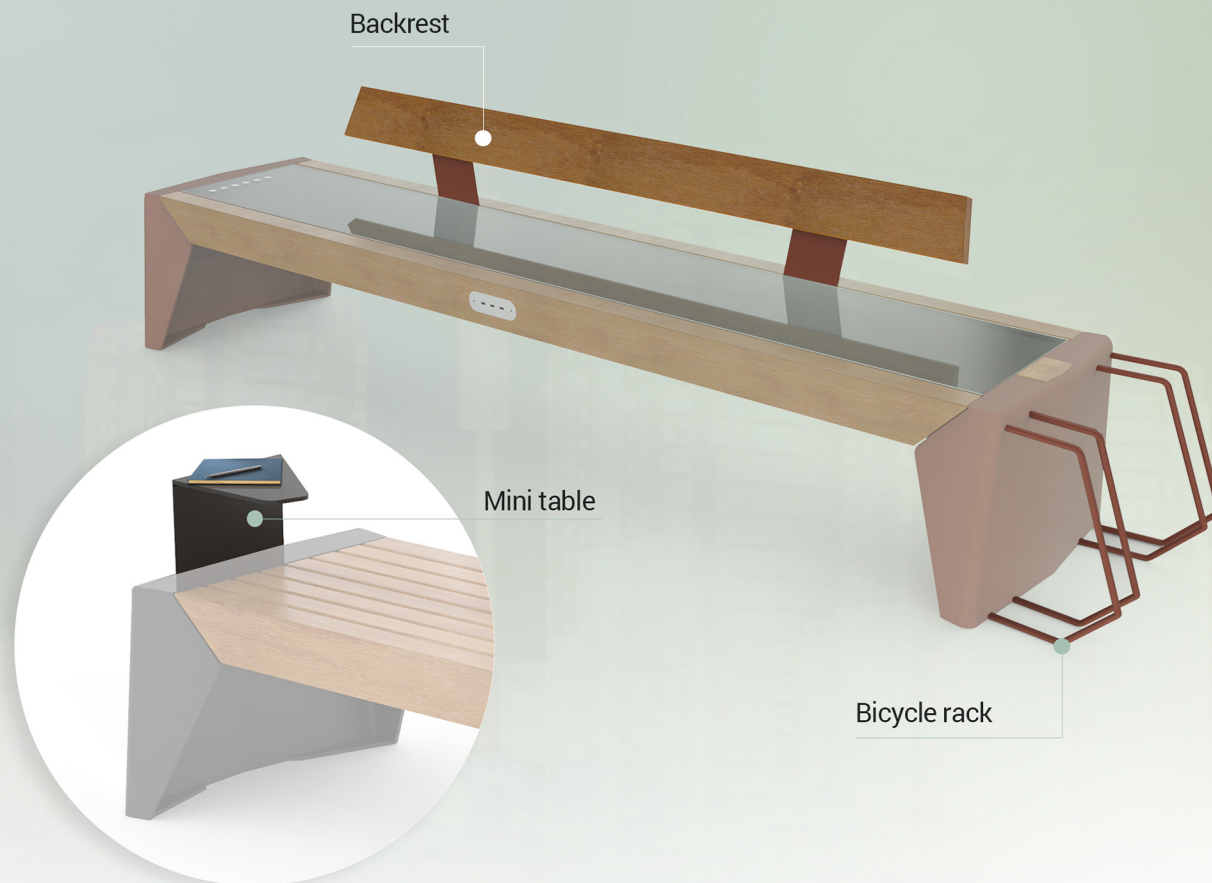

Additional options



For models 02.409 and 02.409.2 there is a choice of **additional functions**:

-  Induction loop for hearing aid users
-  Induction charger
-  Wi-Fi hotspot with a fast internet connection
-  Bluetooth speaker/built in memory

Photon litter and recycling bins



Photon planters

Size L
06.009.L

Size M
06.009.M

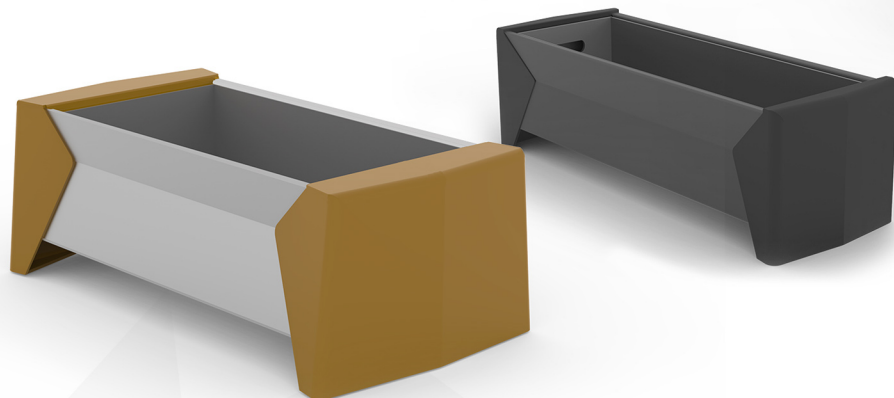

THE PHOTON PRODUCT LINE consists of solar and standard benches, litter bins, recycling bins and planters.

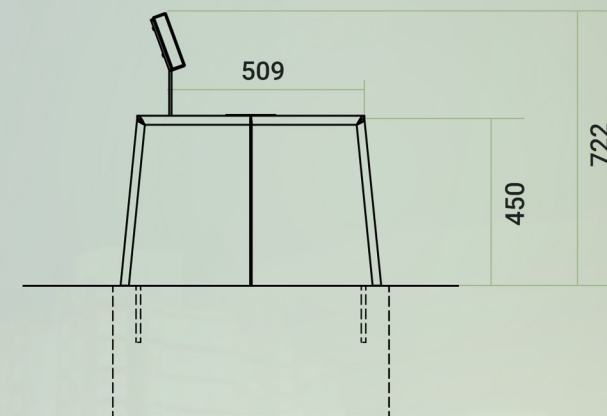
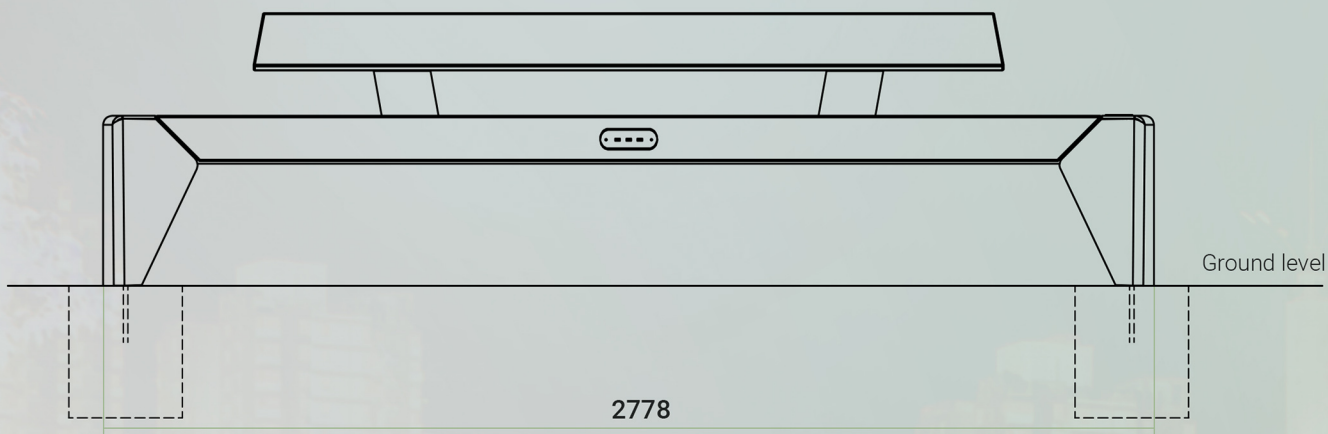

Dimensions in milimeters

Materials:

steel: carbon or stainless
wood: standard, exotic

Technical specification:

photovoltaic panels output power (STC): 100 W
batteries capacity: 36 Ah
operating temperature range: -20°C - 60°C
weight: 205 kg

Standard equipment:

3 USB quick charge ports
ambient light
air cooling system

Additional equipment:

induction charger
bluetooth speaker/speaker with built in memory
audio induction loop
Wi-Fi hotspot



As a leading manufacturer in Poland we always do our best to meet the customer's requirements. ZANO is equally comfortable and experienced in designing for different types of street furniture projects. We are passionate about creating beautiful, functional, sustainable models. This is achieved through a process of focused listening that seeks to truly understand and respond to the inherent nuances of each particular client.

Technical department:
Wojciech Kapuscik | Project engineer | +48 12 636 90 27 | w.kapuscik@zano.pl

Sales department:
Lindego 7a 30-148 Cracow, Poland | +48 12 636 89 25 | office@zano.pl

